

## CA MD RANGE

In-line centrifugal fans in metal

Painted sheet steel mixed flow duct fans, installed in false ceilings or in attics. The ideal low-visual impact ventilation solution for residential, commercial or industrial premises (kitchens, toilets, laboratories, bars, restaurants, laundries, shops, etc).

### VERSIONS

8 models, with nominal diameter between 100 and 315 mm.

### KEY FEATURES

- Built to withstand weathering and high temperatures.
- Standard supplied support brackets.
- High protection rating from dust and water for safe use in industrial environments.
- Wide continuous operation temperature range (-25 °C / + 50 °C).
- Can be installed horizontally, vertically or sloping.

### TECHNICAL FEATURES

- Pickled, phosphate-coated steel sheet casing that has been painted with polyester paint against aggressive weathering.
- Motor-holder built into the boxes housing the mains connection terminals and the flow conditioner fins, constructed in self-extinguishing plastic resin (V0).
- 3-speed fans that can be set using optional device TRIO-CA (code 12869), composed of:
  - AC motors with thermal overload cut-out and shafts turning on ball bearings to guarantee long lasting continuous service (at least 30,000 h) at the maximum plate temperature.
  - Backward-curve, heat resistant plastic resin blade impellers loaded with glass fibre to combine structural strength and dimensional stability.
- Galvanised steel sheet brackets for wall, ceiling and false ceiling installation.
- Possibility of connecting to remote environmental temperature, humidity, smoke and presence sensors (optional).
- Performance and safety certified by third party body (IMQ).
- Protection rating from dusts and water: IP44 (appliance ducted in extraction and delivery).
- Insulation Class: II .

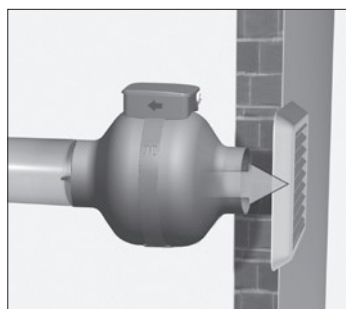



TECHNICAL DATA

Models	Code	V~50HZ	Max Airflow			Max Pressure		LP DB(A) 3m	Max °C	KG		
			W min/med/max	A min/med/max	RPM min/med/max	m³/h min/med/max	l/s min/med/max				mmH <sub>2</sub> O min/med/max	Pa min/med/max
CA 100 MD	16150	230	26	0,22	1190	163	45,0	19,9	195,9	32,3*	50	2,97
			47	0,30	1810	250	69,4	33	323,4	-		
			85	0,40	2370	337	93,0	38,9	381,6	43,2*		
CA 125 MD	16151	230	26	0,22	1130	210	58,0	17,6	172,6	30,8*	50	3,0
			47	0,30	1685	315	87,5	30,7	301,3	-		
			85	0,40	2300	445	123,6	36,8	361,4	45,9*		
CA 150 MD E	16163	230	26	0,22	1160	230	63,8	12,3	121,0	42,3**	50	4,9
			47	0,30	1725	350	97,2	25,3	248,7	-		
			85	0,38	2650	535	148,6	44,3	435,1	53,2**		
CA 150 Q MD	16152	230	26	0,22	1160	230	63,8	12,3	121,1	34,7*	50	2,98
			47	0,30	1725	350	97,2	25,3	248,2	-		
			85	0,40	2340	470	130,5	33,3	327,0	48,1*		
CA 160 MD E	16164	230	39	0,35	1130	325	90,2	32,7	321,5	43,4*	50	4,9
			53	0,36	2160	450	125	41,8	409,8	-		
			85	0,38	2665	555	154,1	44,0	431,8	53,4*		
CA 200 MD E	16165	230	39	0,35	1440	412	114,0	36,0	353,0	36,2**	50	4,8
			57	0,38	2140	620	172,2	45,0	441,0	-		
			89	0,43	2630	775	215,0	45,0	441,0	48,1**		
CA 250 MD E	16166	230	50	0,47	1410	540	150,0	33,7	330,8	38,3**	50	5,3
			82	0,55	2120	805	223,6	49,2	482,6	-		
			120	0,53	2635	1010	280,5	54,8	537,6	52,7**		
CA 315 MD E	16167	230	50	0,47	1510	570	158,3	36,0	353,2	41,8**	50	7,0
			82	0,54	2150	830	230,5	50,7	497,3	-		
			120	0,53	2630	1015	281,9	55,5	544,9	52,3**		

\* Sound pressure level measured at 3 m in free field conditions with long-cased appliance in delivery mode in accordance with standard EN ISO 3741.

\*\* Sound pressure level measured at 3 m in free field conditions with long-cased appliance in delivery mode in accordance with standard EN ISO 9614.

## CA MD RANGE

Available only for Extra EU market and therefore not in compliance with Reg. ErP 2018

- 8 models, with nominal diameter between 100 and 315 mm.
- 2-speed motors with thermal overload cut-out and shaft turning in ball bearings to guarantee long lasting continuous service (at least 30,000 h) at the maximum plate temperature. Speed adjustment using Vortice accessory devices.
- Performance and safety certified by third party body (IMQ).

TECHNICAL DATA - AVAILABLE ONLY FOR EXTRA EU MARKET

Models	Code	V~50/60HZ	Max Airflow			Max Pressure		LP DB(A) 3m	Max °C	KG		
			W min/max	A min/max	RPM min/max	m³/h min/max	l/s min/max				mmH <sub>2</sub> O min/max	Pa min/max
CA 100 MD*	16107	220-240	60 85	0.30 0.40	1730 2450	220 340	61 94	30 39	294 383	32.2** 43.2**	50	2.97
CA 125 MD*	16108	220-240	60 85	0.30 0.40	1580 2380	280 450	78 125	27 37	265 363	30.8** 45.9**	50	3.0
CA 150 MD*	16153	220-240	110 155	0.50 0.70	1815 2080	570 770	188 214	44 54	432 530	40.7 48.0	50	5.52
CA 150 Q MD*	16109	220-240	60 85	0.30 0.40	1430 2350	300 500	83 139	21 35	206 343	34.7** 48.1**	50	2.98
CA 160 M*	16154	220-240	110 155	0.55 0.70	1654 2080	640 840	178 228	41 50	402 491	40.7 47.4	50	5.47
CA 200 MD*	16155	220-240	110 155	0.55 0.70	1700 2100	820 1050	228 292	37 48	363 471	43.8 49.6	50	5.43
CA 250 MD*	16156	220-240	115 200	0.55 0.90	1800 2420	950 1300	264 361	42 56	412 549	46.7 55.9	50	6.55
CA 315 MD*	16157	220-240	190 280	0.85 1.25	1940 2500	1350 1800	375 500	52 72	510 706	52.4 57.7	50	9.47

\* Available only for the Extra EU market

\*\* Sound pressure level measured at 3 m in free field conditions with long-cased appliance in delivery mode in accordance with standard EN ISO 3741.

\*\*\* Sound pressure level measured at 3 m in free field conditions with long-cased appliance in delivery mode in accordance with standard EN ISO 9614.



## COMMERCIAL VENTILATION

### CA MD RANGE

#### ENERGY DATA FOR REGULATION N° 1254/2014/UE

	UNIT OF MEASURE	CA 160 MD E	CA 200 MD E	CA 250 MD E	CA 315 MD E
<b>CODE</b>		16164	16165	16166	16167
Supplier's name or trade mark	-	Vortice	Vortice	Vortice	Vortice
SFPint	W(m³/s)	482,85	382,78	397,50	385,03
Declared typology	-	NRVU-U**	NRVU-U**	NRVU-U**	NRVU-U**
Type of drive	-	MSD***	MSD***	MSD***	MSD***
Type of heat recovery system HRS	-	None	None	None	None
Nominal NRVU flow rate	m³/s	0,13611	0,21389	0,2747	0,2791
Effective electric power input	kW	0,088	0,089	0,127	0,123
Face velocity at design flow rate	m/s	6,7696	6,8083	5,5966	3,5822
Nominal external pressure ( $\Delta p_s$ , ext)	Pa	70	12	21	18
Internal pressure drop of ventilation components ( $\Delta p_s$ ,int)	Pa	279	135	126	122
Internal pressure drop of non-ventilation components ( $\Delta p_s$ ,add)	Pa	0	0	0	0
Static efficiency of fans used in accordance with Regulation (EU) N. 327/2011	%	43,2	35,3	31,8	31,8
Declared maximum internal leakage rate of the casing of ventilation units	%	NA*	NA*	NA*	NA*
Declared maximum external leakage rate of the casing of ventilation units	%	5,9	4,2	2,3	2,2
Energy performance energy or classification of the filters	-	NA*	NA*	NA*	NA*
Description of visual filter warning	-	NA*	NA*	NA*	NA*
Casing sound power level	LWA[dB(A)]	74	69	73	73

	UNIT OF MEASURE	CA 100 MD	CA 125 MD	CA 150 MD E	CA 150 Q MD
<b>CODE</b>		16150	16151	16163	16152
Supplier's name or trade mark	-	Vortice	Vortice	Vortice	Vortice
SFPint	W(m³/s)	602,29	478,53	567,30	408,13
Declared typology	-	NRVU-U**	NRVU-U**	NRVU-U**	NRVU-U**
Type of drive	-	MSD***	MSD***	MSD***	MSD***
Type of heat recovery system HRS	-	None	None	None	None
Nominal NRVU flow rate	m³/s	0,07917	0,09861	0,14333	0,10260
Effective electric power input	kW	0,051	0,051	0,086	0,053
Face velocity at design flow rate	m/s	10,08	8,0335	8,1110	5,8003
Nominal external pressure ( $\Delta p_s$ , ext)	Pa	12,8	8,8	15	31,4
Internal pressure drop of ventilation components ( $\Delta p_s$ ,int)	Pa	183	148	255	149
Internal pressure drop of non-ventilation components ( $\Delta p_s$ ,add)	Pa	0	0	0	0
Static efficiency of fans used in accordance with Regulation (EU) N. 327/2011	%	30,4	30,7	44,9	28,8
Declared maximum internal leakage rate of the casing of ventilation units	%	NA*	NA*	NA*	NA*
Declared maximum external leakage rate of the casing of ventilation units	%	3,6	3,0	6,3	2,8
Energy performance energy or classification of the filters	-	NA*	NA*	NA*	NA*
Description of visual filter warning	-	NA*	NA*	NA*	NA*
Casing sound power level	LWA[dB(A)]	64	66	74	69

\*NA: Not applicable - \*\*RVU-U: Non Residential Ventilation Unit - Unidirectional - \*\*\*MSD: Multi-Speed Drive



DIMENSIONS

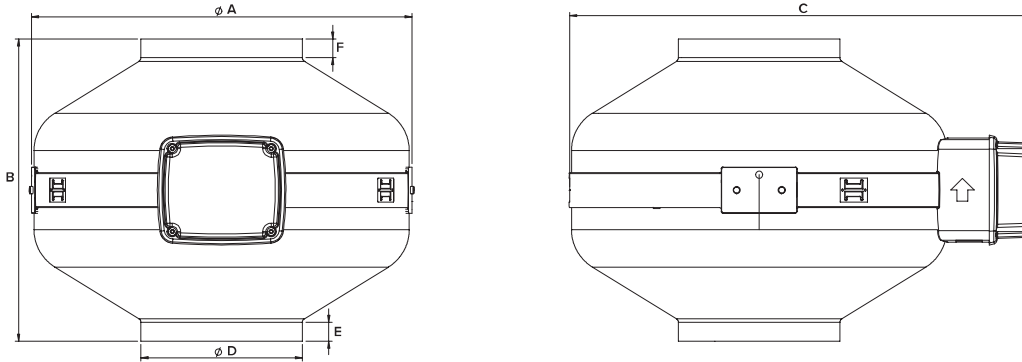

MODELS	ØA	B	C	ØD	E	F
CA 100	255	239	330	97	15	15
CA 125	255	239	330	122	23	23
CA 150 Q	255	239	330	147	30	30
CA 150	347	275	424	147	17	17
CA 160	347	275	424	157	18	18
CA 200	347	275	424	197	20	17
CA 250	347	275	424	247	38	35
CA 315	406	306	488	312	21	30

Dimensions (mm)

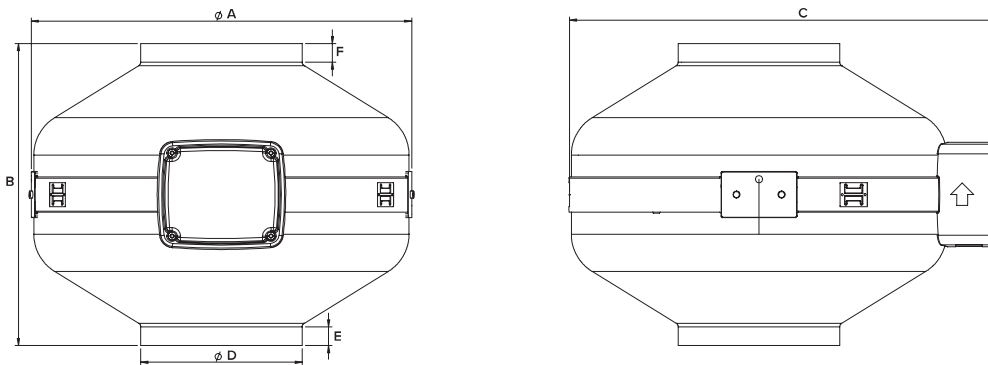

AVAILABLE ONLY FOR EXTRA EU MARKET

MODELS	ØA	B	C	ØD	E	F
CA 100	255	239	300	97	15	15
CA 125	255	239	300	122	23	23
CA 150 Q	255	239	300	147	30	30
CA 150	347	275	424	147	17	17
CA 160	347	375	424	157	18	18
CA 200	347	275	424	197	20	17
CA 250	347	375	394	247	38	35
CA 315	406	306	458	312	21	30

Dimensions (mm)



PERFORMANCES CURVES

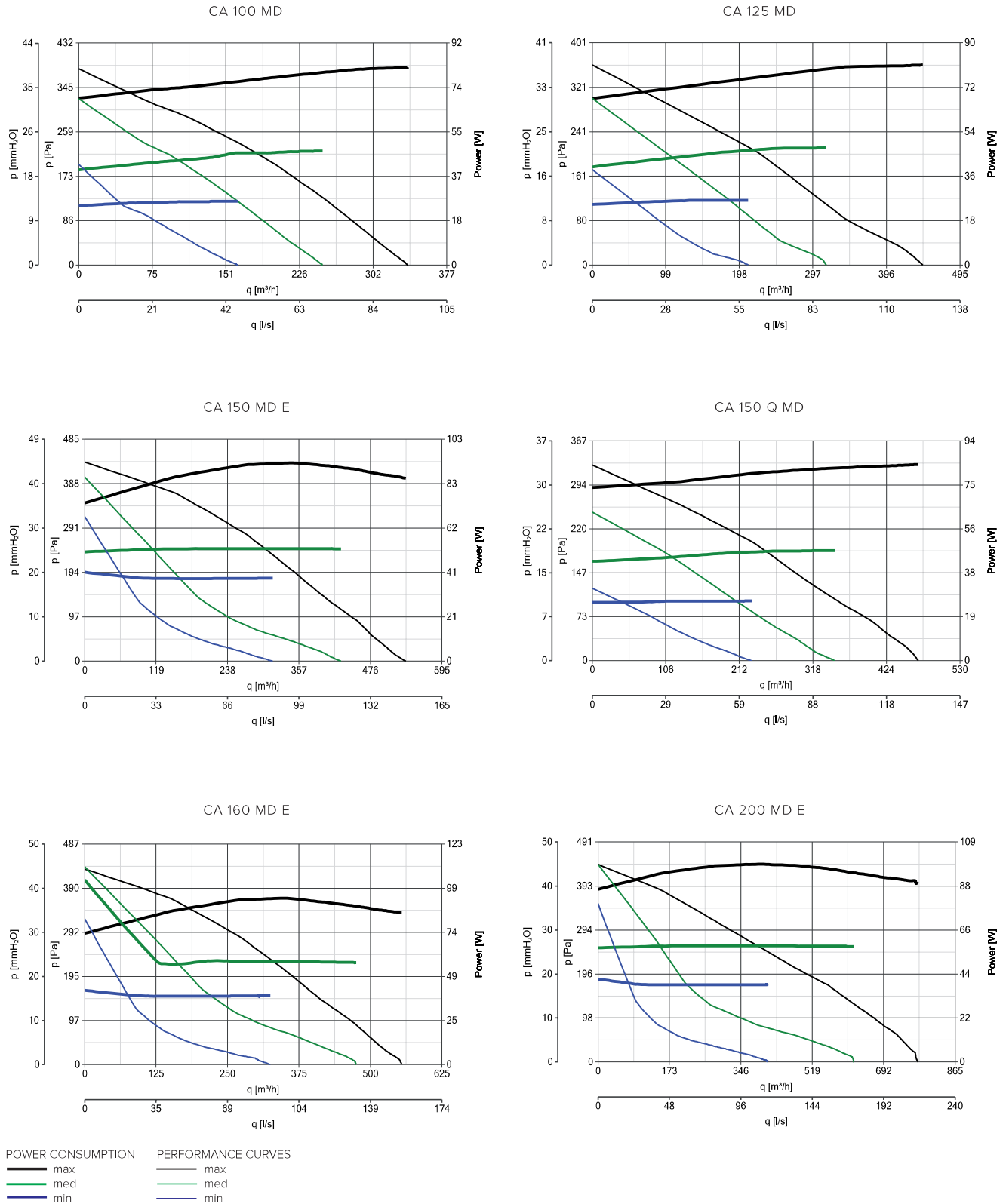



PERFORMANCES CURVES

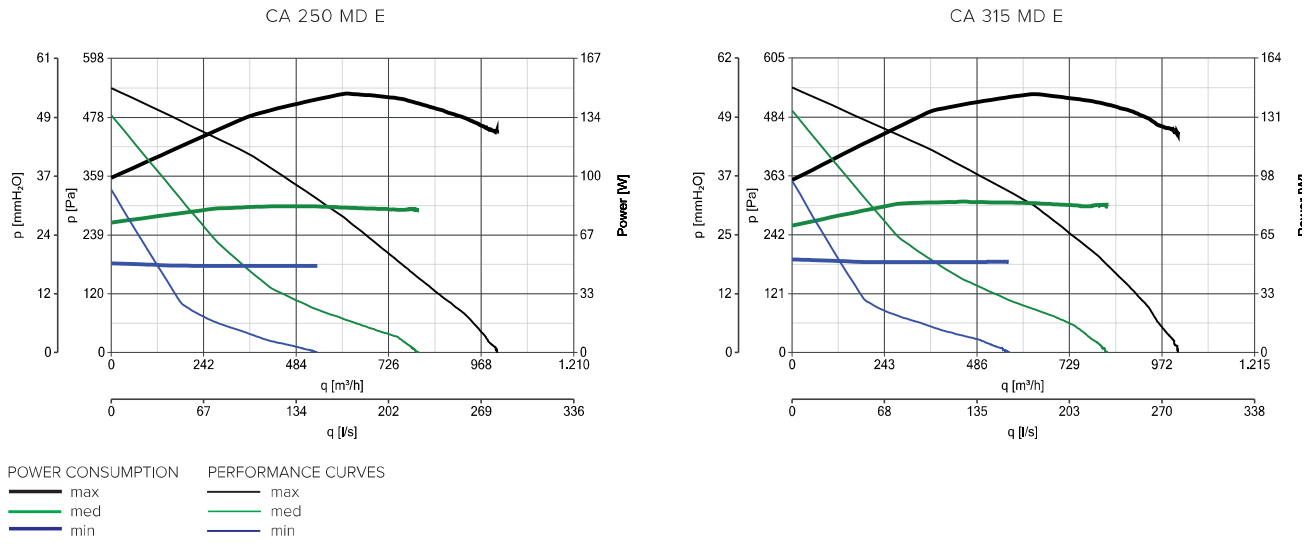



AVAILABLE ONLY FOR EXTRA EU MARKET

CA 100 MD\*

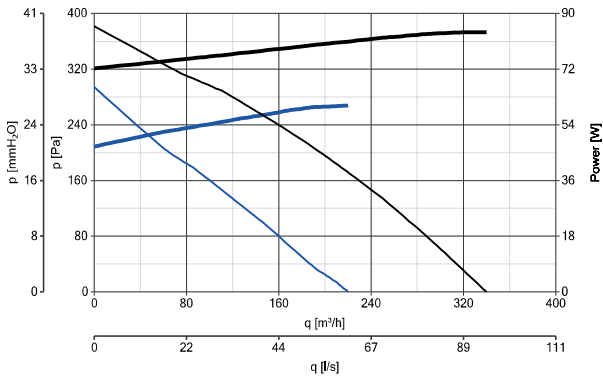

CA 125 MD\*

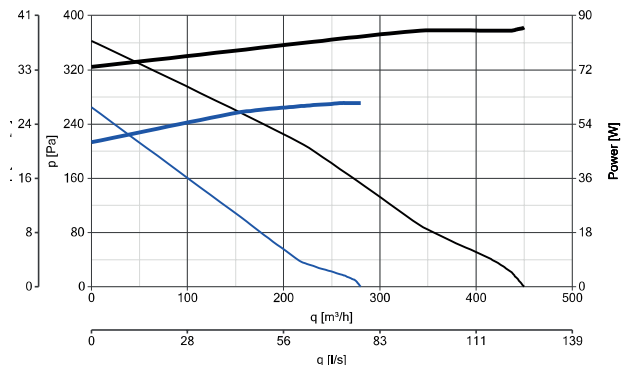

CA 150 MD\*

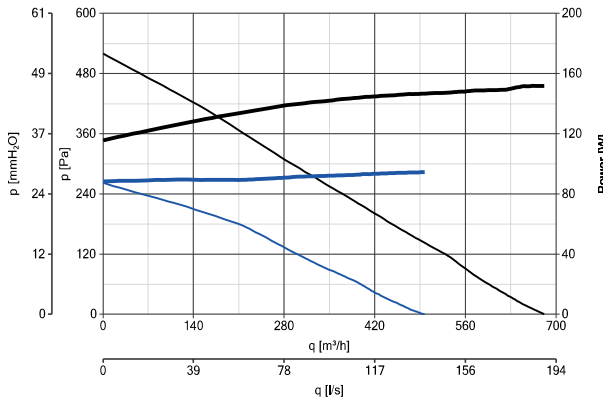

CA 150 Q MD\*

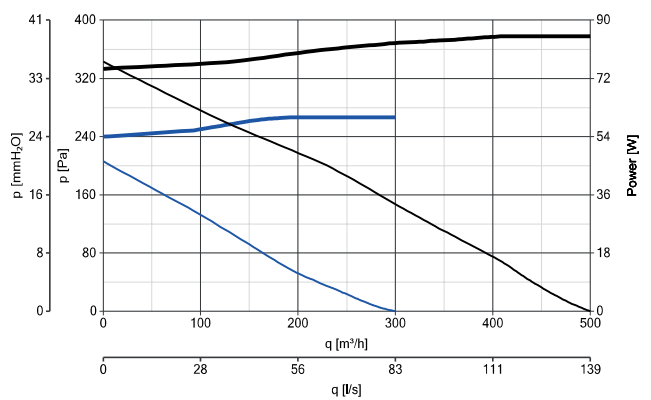

\* Available only for Extra EU markets

CA 160 MD

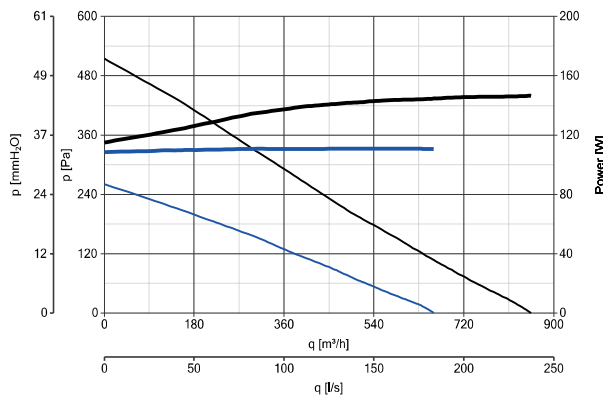

CA 200 MD

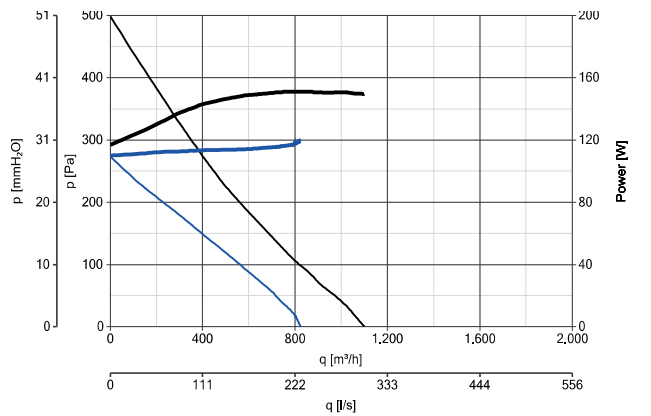

PERFORMANCES CURVES

- max
- min





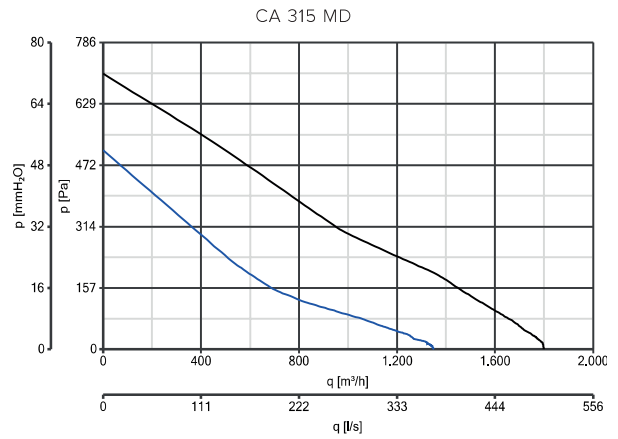
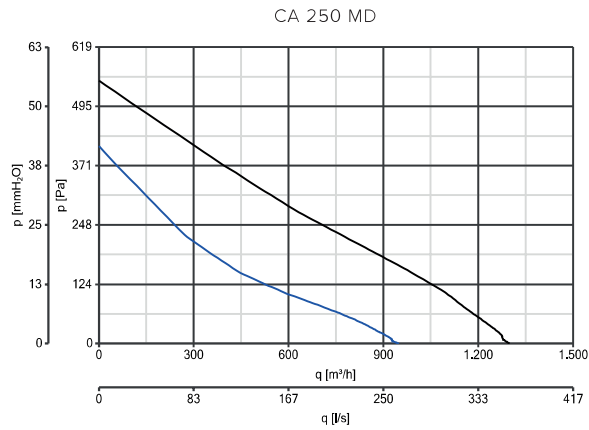

AVAILABLE ONLY FOR EXTRA EU MARKET





PERFORMANCES CURVES

— max  
— min

**CONTROLLERS**

MODELS	DESCRIPTION	CODE	PRODUCT
	<b>C 1.5</b> - ELECTRONIC SPEED CONTROLLER 1.5 A	12966	ALL PRODUCTS
	<b>C 2.5</b> - ELECTRONIC SPEED CONTROLLER 2.5 A	12967	ALL PRODUCTS
	<b>SCNRB</b> - ELECTRONIC SPEED CONTROLLER. BUILT-IN	12971	ALL PRODUCTS
	<b>KIT SCB</b> - BUILT-IN CONTROLLER ADAPTOR	22481	12966 - 12967
	<b>TRIO</b> - 3 SPEED SWITCH FOR WALL AND FLUSH MOUNTING INSIDE UNI 503 STANDARD ELECTRIC BOXES	12869	16150 - 16151 - 16163 - 16152 - 16164 16165 - 16166 - 16167

**ACCESSORIES ON REQUEST**

MODELS	DESCRIPTION	CODE	PRODUCT
	<b>CA-MU</b> - MOUNTING BRACKETS	22674	ALL PRODUCTS
		100 22750	16150 - 16107
		125 22755	16151 - 16108
		150 22760	16152 - 16163 - 16109 - 16153
		200 22765	16165 - 16155
		250 22770	16166 - 16156
		315 22775	16167 - 16157
	<b>CA-G</b> - PROTECTION GRILLE		